

Rekta 30 SAPP - satiné - HO 150mA - Nood - RAL  
07.23001563-9999

**Armatuurgegevens**

Montage	Plafondinbouw
Lichtuittreding	Direct
Afscherming	satiné plexi
Beschermingsgraad	IP 20
Behuizing	Aluminium
Afwerking	RAL kleur naar keuze
Keurmerken	CE, ISO 9001

**Elektrische Gegevens**

Veiligheidsklasse	I
Voeding	230V
Voorschakelapparaat	Stroomvoeding
Noodset	1 uur - zelftest

**Lampgegevens**

Lamptype	LED 3000K
Wattage	3,2W
Bruto lichtstroom	3840
Armatuur vermogen	21,1W
Aantal	6
Levensduur LED module	L80/B10 > 72000h
Kleurtolerantie	MacAdam 3
CRI	>80

**Lichttechnische gegevens**

UGR	25,7/26,0
CIE Fluxcode	50 80 96 100 67

**Afmetingen**

A	1684 mm
---	---------

**Opmerkingen**

satiné - HO 150mA - Noodmodule 1 uur autonomie - RAL

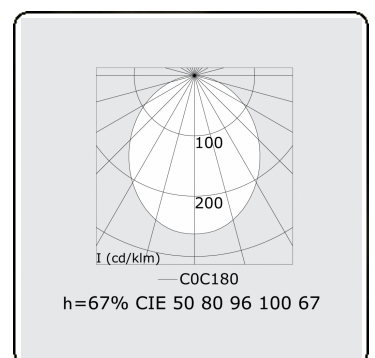

**ENERGY**

Verrijgbaar op aanvraag.

Disponible sur demande.

Available on request.

Auf Anfrage.

**WXYZ**  
kWh/1000h

**MULTILINE®**

2019/2015