

Metro-S 200x100mm - COB (white printed glass) - without recessed housing
36.610054-0021

Fixture details

Mounting	Ground - recessed
Light emission	Indirect
Light distribution	Symmetrical
Fitting cover	Glass
Protection rate	IP 67
Maximum load	1000 kg drive-across (excluding recessing housi
T°	<75° °
Housing	Aluminium/Stainless Steel
Finish	matt black finish RAL 9105
Certificates	CE, ISO 9001



Electric details

Protection class	I
Supply	230V
Control gear box	Current driver

Lamp details

Lamptype	LED 4000K
Wattage	5W
Gross luminous flux	477
Luminaire power	5W
Cover glass	flat - white
Number	1
Lifetime LED module	L80/B10 = 100000h
Color tolerance	MacAdam 3
CRI	80

Photometric details

CIE Fluxcode	0 0 0 0 8
--------------	-----------

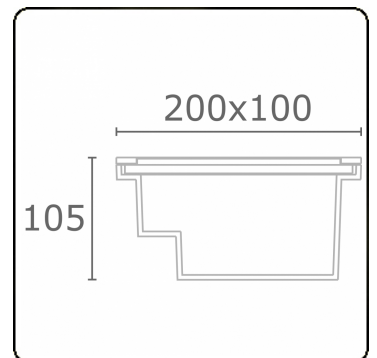

Remarks

200x100mm white printed glass

ENERGY

Verkrijgbaar op aanvraag.

Disponible sur demande.

Available on request.

Auf Anfrage.

WXYZ
kWh/1000h

MULTILINE®

2019/2015