

Rekta 30x110 Direct/Indirect - satiné - HO 150mA - RAL
04.13704563-9999

Armatuurgegevens

Montage	Gependeld
Lichtuittreding	Direct-Indirect
Afscherming	satiné plexi
Beschermingsgraad	IP 20
Behuizing	Aluminium
Afwerking	RAL kleur naar keuze
Keurmerken	CE, ISO 9001

Elektrische Gegevens

Veiligheidsklasse	I
Voeding	230V
Voorschakelapparaat	Stroomvoeding DALI/TD

Lampgegevens

Lamptype	LED 3000K
Wattage	3,2W
Bruto lichtstroom	7040
Armatuur vermogen	38,7W
Aantal	11
Levensduur LED module	L80/B10 > 72000h
Kleurtolerantie	MacAdam 3
CRI	>80

Lichttechnische gegevens

UGR	>19
CIE Fluxcode	50 80 96 100 67
CIE Fluxcode Indirect	00 00 00 00 67

Afmetingen

A	1690 mm
---	---------

Opmerkingen

Pendelarmatuur - Direct/Indirect - HO 150mA - satiné (gelijkglegend) - RAL

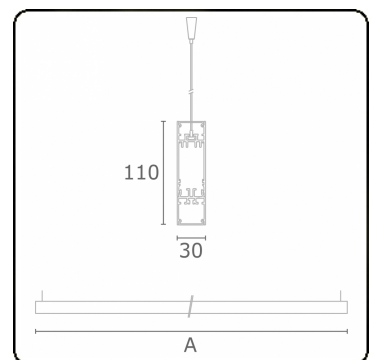

ENERGY

Verrijgbaar op aanvraag.

Disponible sur demande.

Available on request.

Auf Anfrage.

WXYZ
kWh/1000h

MULTILINE®

2019/2015