

Rekta 30x110 Direct/Indirect - satin - HO 150mA - RAL  
04.13704593-9999

**Fixture details**

Mounting	Pendant
Light emission	Direct-Indirect
Fitting cover	satin diffusor
Protection rate	IP 20
Housing	Aluminium
Finish	RAL colour at your choice
Certificates	CE, ISO 9001

**Electric details**

Protection class	I
Supply	230V
Control gear box	Current driver DALI/TD

**Lamp details**

Lamptype	LED 3000K
Wattage	3,2W
Gross luminous flux	10880
Luminaire power	59,8W
Number	17
Lifetime LED module	L80/B10 > 72000h
Color tolerance	MacAdam 3
CRI	>80

**Photometric details**

UGR	>19
CIE Fluxcode	50 80 96 100 67
CIE Fluxcode Indirect	00 00 00 00 67

**Dimensions**

A	2530 mm
---	---------

**Remarks**

Suspended luminaire - Direct/Indirect - HO 150mA - satin (flush) - RAL

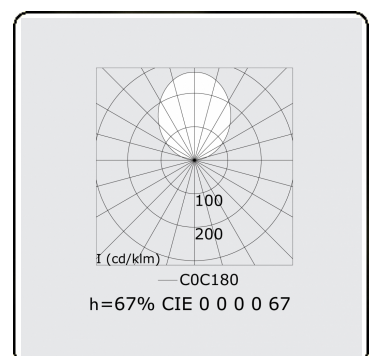
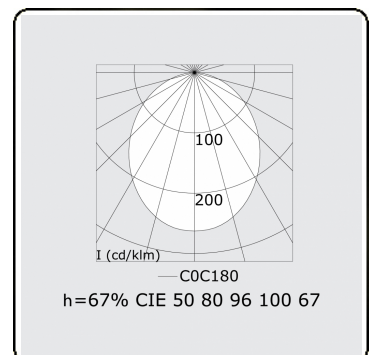
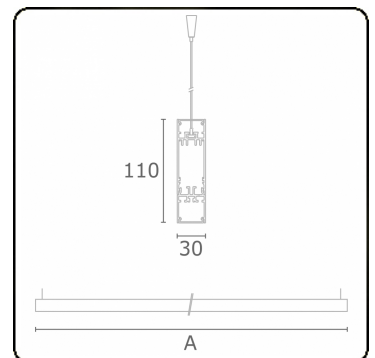

**ENERGY**

Verkrijgbaar op aanvraag.

Disponible sur demande.

Available on request.

Auf Anfrage.

**WXYZ**  
kWh/1000h

**MULTILINE®**

2019/2015