

Twinline Direct - BAP - LO 400mA - RAL
04.14020153-9999

Armatuurgegevens

Montage	Gependeld
Lichtuittreding	Direct
Afscherming	BAP raster
Beschermingsgraad	IP 20
Behuizing	Aluminium
Afwerking	RAL kleur naar keuze
Keurmerken	CE, ISO 9001

Elektrische Gegevens

Veiligheidsklasse	I
Voeding	230V
Voorschakelapparaat	Stroomvoeding

Lampgegevens

Lamptype	LED 3000K
Wattage	4,5W
Bruto lichtstroom	7800
Armatuur vermogen	49,5W
Aantal	5
Levensduur LED module	L80/B10 > 72000h
Kleurtolerantie	MacAdam 3
CRI	>80

Lichttechnische gegevens

UGR	<19
CIE Fluxcode	90 99 100 100 68

Afmetingen

A	1410 mm
---	---------

Opmerkingen

Pendelarmatuur - Direct - LO 400mA - BAP raster - RAL

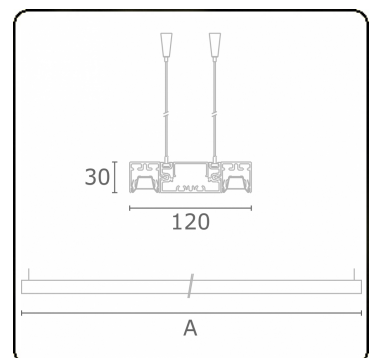

ENERGY

Verrijgbaar op aanvraag.

Disponible sur demande.

Available on request.

Auf Anfrage.

WXYZ
kWh/1000h

MULTILINE®

2019/2015