

Twinline Direct - VDT - LO 400mA - RAL
04.14020153-9999

Fixture details

Mounting	Pendant
Light emission	Direct
Fitting cover	VDT louvre
Protection rate	IP 20
Housing	Aluminium
Finish	RAL colour at your choice
Certificates	CE, ISO 9001

Electric details

Protection class	I
Supply	230V
Control gear box	Current driver

Lamp details

Lamptype	LED 3000K
Wattage	4,5W
Gross luminous flux	7800
Luminaire power	49,5W
Number	5
Lifetime LED module	L80/B10 > 72000h
Color tolerance	MacAdam 3
CRI	>80

Photometric details

UGR	<19
CIE Fluxcode	90 99 100 100 68

Dimensions

A	1410 mm
---	---------

Remarks

Suspended luminaire - Direct - LO 400mA - VDT louvre - RAL

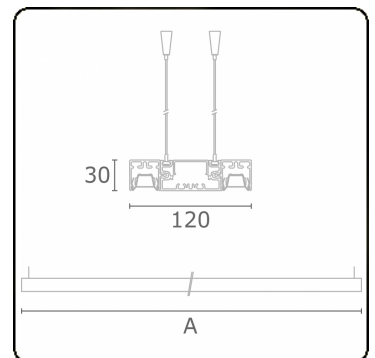

ENERGY

Verrijgbaar op aanvraag.

Disponible sur demande.

Available on request.

Auf Anfrage.

MULTILINE®

WXYZ
kWh/1000h

2019/2015