

Twinline Direct - BAP - LO 400mA - RAL  
04.14024104-9999

**Armatuurgegevens**

Montage	Gependeld
Lichtuittreding	Direct
Afscherming	BAP raster
Beschermingsgraad	IP 20
Behuizing	Aluminium
Afwerking	RAL kleur naar keuze
Keurmerken	CE, ISO 9001

**Elektrische Gegevens**

Veiligheidsklasse	I
Voeding	230V
Voorschakelapparaat	Stroomvoeding DALI/TD

**Lampgegevens**

Lamptype	LED 4000K
Wattage	4,5W
Bruto lichtstroom	16400
Armatuur vermogen	99,0W
Aantal	10
Levensduur LED module	L80/B10 > 72000h
Kleurtolerantie	MacAdam 3
CRI	>80

**Lichttechnische gegevens**

UGR	<19
CIE Fluxcode	90 99 100 100 68

**Afmetingen**

A	2810 mm
---	---------

**Opmerkingen**

Pendelarmatuur - Direct - LO 400mA - BAP raster - RAL

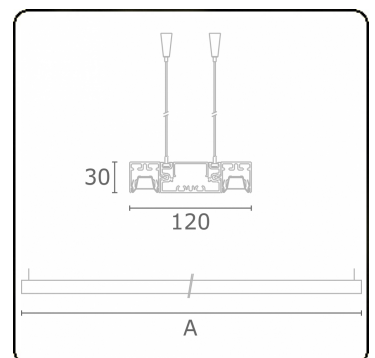

**ENERGY**

Verrijgbaar op aanvraag.

Disponible sur demande.

Available on request.

Auf Anfrage.

**WXYZ**  
kWh/1000h

**MULTILINE®**

2019/2015