

Edge 55 S Direct - MPO - HO 150mA - ANO
04.74010503-0001

Armatuurgegevens

Montage	Gependeld
Lichtuittreding	Direct
Afscherming	micro prismatische optiek
Beschermingsgraad	IP 20
Behuizing	Aluminium
Afwerking	geanodiseerde afwerking
Keurmerken	CE, ISO 9001

Elektrische Gegevens

Veiligheidsklasse	I
Voeding	230V
Voorschakelapparaat	Stroomvoeding

Lampgegevens

Lamptype	LED 3000K
Wattage	3,2W
Bruto lichtstroom	6400
Armatuur vermogen	35,2W
Aantal	10
Levensduur LED module	L80/B10 > 72000h
Kleurtolerantie	MacAdam 3
CRI	>80

Lichttechnische gegevens

UGR	>19
CIE Fluxcode	58 89 98 100 50

Afmetingen

A	2816 mm
---	---------

Opmerkingen

Pendelarmatuur - Direct - HO 150mA - MPO - ANO

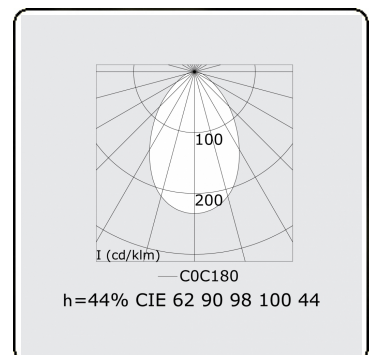
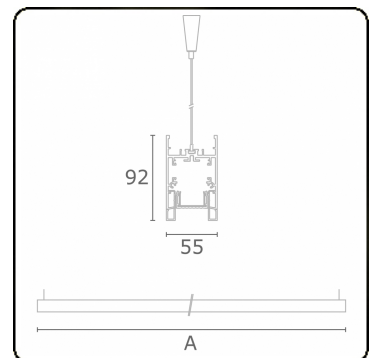

ENERGY

Verrijgbaar op aanvraag.

Disponible sur demande.

Available on request.

Auf Anfrage.

WXYZ
kWh/1000h

MULTILINE®

2019/2015