

Edge 55 S Direct - MPO - HO 150mA - ANO
04.74014543-0001

Fixture details

Mounting	Pendant
Light emission	Direct
Fitting cover	micro prismatic diffuser
Protection rate	IP 20
Housing	Aluminium
Finish	anodized finish
Certificates	CE, ISO 9001



Electric details

Protection class	I
Supply	230V
Control gear box	Current driver DALI/TD

Lamp details

Lamptype	LED 3000K
Wattage	3,2W
Gross luminous flux	2560
Luminaire power	14,1W
Number	4
Lifetime LED module	L80/B10 > 72000h
Color tolerance	MacAdam 3
CRI	>80

Photometric details

UGR	>19
CIE Fluxcode	58 89 98 100 50

Dimensions

A	1136 mm
---	---------

Remarks

Suspended luminaire - Direct - HO 150mA - MPO - ANO

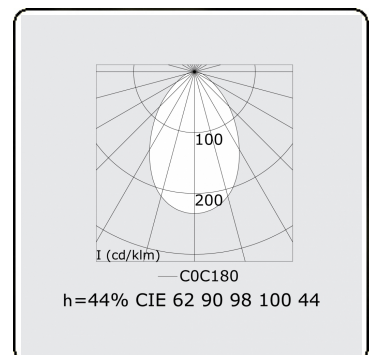
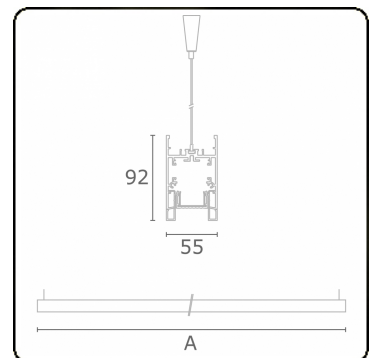

ENERGY

Verrijgbaar op aanvraag.

Disponible sur demande.

Available on request.

Auf Anfrage.

WXYZ
kWh/1000h

MULTILINE®

2019/2015