

Edge 55 S Direct - MPO - HO 150mA - ANO  
04.74014544-0001

**Fixture details**

Mounting	Pendant
Light emission	Direct
Fitting cover	micro prismatic diffuser
Protection rate	IP 20
Housing	Aluminium
Finish	anodized finish
Certificates	CE, ISO 9001



**Electric details**

Protection class	I
Supply	230V
Control gear box	Current driver DALI/TD

**Lamp details**

Lamptype	LED 4000K
Wattage	3,2W
Gross luminous flux	2680
Luminaire power	14,1W
Number	4
Lifetime LED module	L80/B10 > 72000h
Color tolerance	MacAdam 3
CRI	>80

**Photometric details**

UGR	>19
CIE Fluxcode	58 89 98 100 50

**Dimensions**

A	1136 mm
---	---------

**Remarks**

Suspended luminaire - Direct - HO 150mA - MPO - ANO

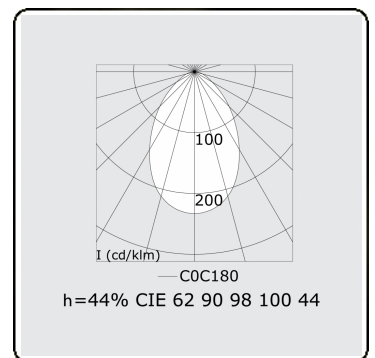
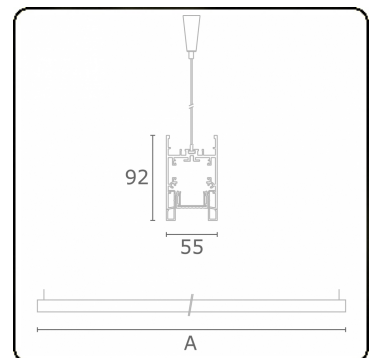

**ENERGY**

Verrijgbaar op aanvraag.

Disponible sur demande.

Available on request.

Auf Anfrage.

**WXYZ**  
kWh/1000h

**MULTILINE®**

2019/2015