

Edge 55 S Direct - MPO - HO 150mA - ANO
07.74010553-0001

Armatuurgegevens

Montage	Plafondinbouw
Lichtuittreding	Direct
Afscherming	micro prismatische optiek
Beschermingsgraad	IP 20
Behuizing	Aluminium
Afwerking	geanodiseerde afwerking
Keurmerken	CE, ISO 9001



Elektrische Gegevens

Veiligheidsklasse	I
Voeding	230V
Voorschakelapparaat	Stroomvoeding

Lampgegevens

Lamptype	LED 3000K
Wattage	3,2W
Bruto lichtstroom	3200
Armatuur vermogen	17,6W
Aantal	5
Levensduur LED module	L80/B10 > 72000h
Kleurtolerantie	MacAdam 3
CRI	>80

Lichttechnische gegevens

UGR	>19
CIE Fluxcode	58 89 98 100 50

Afmetingen

A	1416 mm
---	---------

Opmerkingen

Inbouwarmatuur (randloos) - Direct - HO 150mA - MPO - ANO

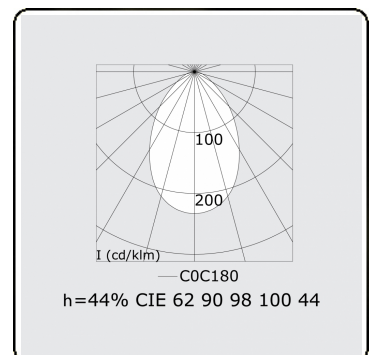
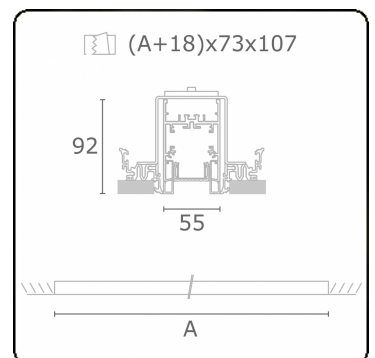

ENERGY

Verrijgbaar op aanvraag.

Disponible sur demande.

Available on request.

Auf Anfrage.

WXYZ
kWh/1000h

MULTILINE®

2019/2015