

Edge 55 S Direct - MPO - HO 150mA - ANO
07.74010553-0001

Fixture details

| | |
|-----------------|--------------------------|
| Mounting | Ceiling recessed |
| Light emission | Direct |
| Fitting cover | micro prismatic diffuser |
| Protection rate | IP 20 |
| Housing | Aluminium |
| Finish | anodized finish |
| Certificates | CE, ISO 9001 |



Electric details

| | |
|------------------|----------------|
| Protection class | I |
| Supply | 230V |
| Control gear box | Current driver |

Lamp details

| | |
|---------------------|------------------|
| Lamptype | LED 3000K |
| Wattage | 3,2W |
| Gross luminous flux | 3200 |
| Luminaire power | 17,6W |
| Number | 5 |
| Lifetime LED module | L80/B10 > 72000h |
| Color tolerance | MacAdam 3 |
| CRI | >80 |

Photometric details

| | |
|--------------|-----------------|
| UGR | >19 |
| CIE Fluxcode | 58 89 98 100 50 |

Dimensions

| | |
|---|---------|
| A | 1416 mm |
|---|---------|

Remarks

Recessed luminaire (trimless) - Direct - HO 150mA - MPO - ANO

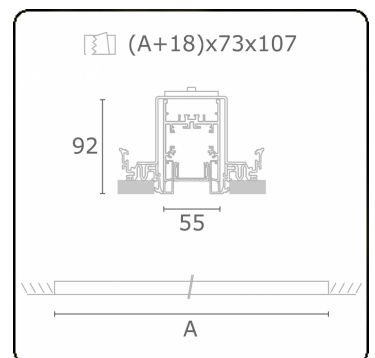

ENERGY

Verrijgbaar op aanvraag.

Disponible sur demande.

Available on request.

Auf Anfrage.

MULTILINE® **WXYZ**
kWh/1000h

2019/2015