

Edge 55 S Direct - MPO - HO 150mA - ANO  
07.74014583-0001

**Armatuurgegevens**

Montage	Plafondinbouw
Lichtuittreding	Direct
Afscherming	micro prismatische optiek
Beschermingsgraad	IP 20
Behuizing	Aluminium
Afwerking	geanodiseerde afwerking
Keurmerken	CE, ISO 9001



**Elektrische Gegevens**

Veiligheidsklasse	I
Voeding	230V
Voorschakelapparaat	Stroomvoeding DALI/TD

**Lampgegevens**

Lamptype	LED 3000K
Wattage	3,2W
Bruto lichtstroom	5120
Armatuur vermogen	28,2W
Aantal	8
Levensduur LED module	L80/B10 > 72000h
Kleurtolerantie	MacAdam 3
CRI	>80

**Lichttechnische gegevens**

UGR	>19
CIE Fluxcode	58 89 98 100 50

**Afmetingen**

A	2256 mm
---	---------

**Opmerkingen**

Inbouwarmatuur (randloos) - Direct - HO 150mA - MPO - ANO

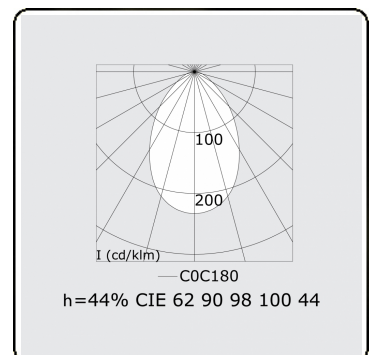
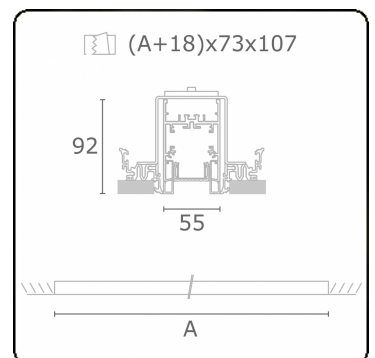

**ENERGY**

Verrijgbaar op aanvraag.

Disponible sur demande.

Available on request.

Auf Anfrage.

**WXYZ**  
kWh/1000h

**MULTILINE®**

2019/2015