

Edge 55 B Direct/Indirect - satiné - HO 150mA - RAL  
04.74304593-9999

**Armatuurgegevens**

Montage	Gependeld
Lichtuittreding	Direct-Indirect
Afscherming	satiné plexi
Beschermingsgraad	IP 20
Behuizing	Aluminium
Afwerking	RAL kleur naar keuze
Keurmerken	CE, ISO 9001



**Elektrische Gegevens**

Veiligheidsklasse	I
Voeding	230V
Voorschakelapparaat	Stroomvoeding DALI/TD

**Lampgegevens**

Lamptype	LED 3000K
Wattage	3,2W
Bruto lichtstroom	10880
Armatuur vermogen	59,8W
Aantal	17
Levensduur LED module	L80/B10 > 72000h
Kleurtolerantie	MacAdam 3
CRI	>80

**Lichttechnische gegevens**

UGR	>19
CIE Fluxcode	56 87 99 99 59
CIE Fluxcode Indirect	00 00 00 00 73

**Afmetingen**

A	2536 mm
---	---------

**Opmerkingen**

Pendelarmatuur - Direct/Indirect - HO 150mA - satiné - RAL

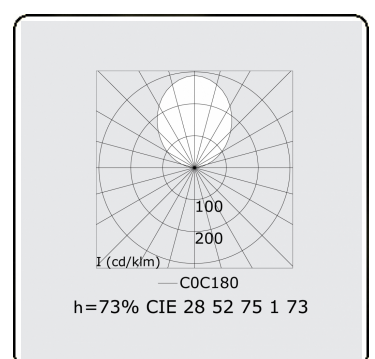
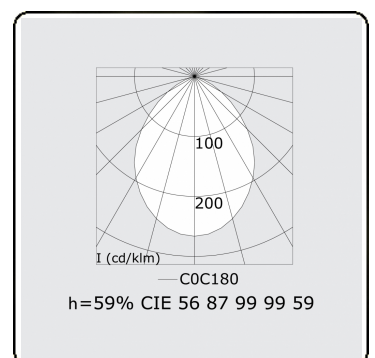
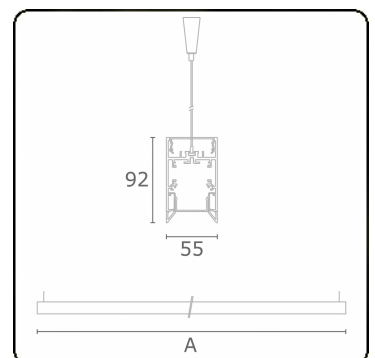

**ENERGY**

Verrijgbaar op aanvraag.

Disponible sur demande.

Available on request.

Auf Anfrage.

**WXYZ**  
kWh/1000h

**MULTILINE®**

2019/2015