

Edge 55 B Direct/Indirect - satiné - HO 150mA - RAL
04.74304554-9999

Armatuurgegevens

| | |
|-------------------|----------------------|
| Montage | Gependeld |
| Lichtuittreding | Direct-Indirect |
| Afscherming | satiné plexi |
| Beschermingsgraad | IP 20 |
| Behuizing | Aluminium |
| Afwerking | RAL kleur naar keuze |
| Keurmerken | CE, ISO 9001 |



Elektrische Gegevens

| | |
|---------------------|-----------------------|
| Veiligheidsklasse | I |
| Voeding | 230V |
| Voorschakelapparaat | Stroomvoeding DALI/TD |

Lampgegevens

| | |
|-----------------------|------------------|
| Lamptype | LED 4000K |
| Wattage | 3,2W |
| Bruto lichtstroom | 6030 |
| Armatuur vermogen | 31,7W |
| Aantal | 9 |
| Levensduur LED module | L80/B10 > 72000h |
| Kleurtolerantie | MacAdam 3 |
| CRI | >80 |

Lichttechnische gegevens

| | |
|-----------------------|----------------|
| UGR | >19 |
| CIE Fluxcode | 56 87 99 99 59 |
| CIE Fluxcode Indirect | 00 00 00 00 73 |

Afmetingen

| | |
|---|---------|
| A | 1416 mm |
|---|---------|

Opmerkingen

Pendelarmatuur - Direct/Indirect - HO 150mA - satiné - RAL

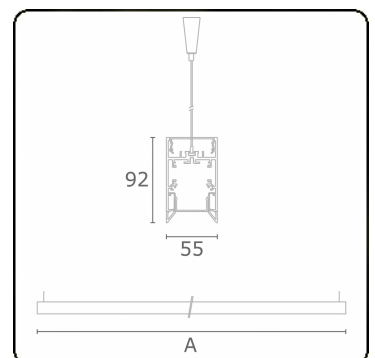

ENERGY

Verrijgbaar op aanvraag.

Disponible sur demande.

Available on request.

Auf Anfrage.

WXYZ
kWh/1000h

MULTILINE®

2019/2015