

Score curved Direct - satin - HO 325mA - ANO
04.87204663-0001

Fixture details

Mounting	Pendant
Light emission	Direct
Fitting cover	satin diffusor
Protection rate	IP 20
Housing	Aluminium
Finish	anodized finish
Certificates	CE, ISO 9001



Electric details

Protection class	I
Supply	230V
Control gear box	Current driver DALI/TD

Lamp details

Lamptype	LED 3000K
Wattage	7,2W
Gross luminous flux	7680
Luminaire power	47,5W
Number	6
Lifetime LED module	L80/B10 > 72000h
Color tolerance	MacAdam 3
CRI	>80

Photometric details

UGR	>19
CIE Fluxcode	54 85 98 99 72

Dimensions

A	1704 mm
---	---------

Remarks

Suspended luminaire - Direct - HO 325mA - MPO - ANO

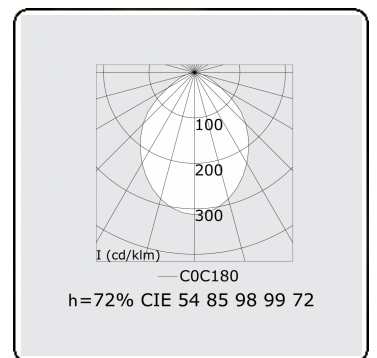
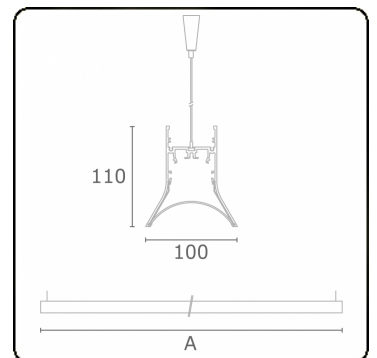

ENERGY

A
 Verkrijgbaar op aanvraag.
B
 Disponible sur demande.
C
D
 Available on request.
E
F
 Auf Anfrage.
G

WXYZ
kWh/1000h

MULTILINE® 2019/2015