

Tube 70 T1 - satiné - HO 150mA - dubbele wartel
35.90210543-0000

Armatuurgegevens

Montage	Wand Opbouw
Lichtuittreding	Direct
Afscherming	satiné plexi
Beschermingsgraad	IP 65
Behuizing	Polycarbonaat/PMMA
Afwerking	satiné
Keurmerken	CE, ISO 9001

Elektrische Gegevens

Veiligheidsklasse	I
Voeding	230V
Voorschakelapparaat	Stroomvoeding

Lampgegevens

Lamptype	LED 3000K
Wattage	3,2W
Bruto lichtstroom	2540
Armatuur vermogen	14,1W
Aantal	4
Levensduur LED module	L80/B10 > 72000h
Kleurtolerantie	MacAdam 3
CRI	>80

Lichttechnische gegevens

CIE Fluxcode	45 74 91 93 85
--------------	----------------

Afmetingen

A	1200 mm
---	---------

Opmerkingen

Wandarmatuur - satiné - HO 150mA - dubbele wartel

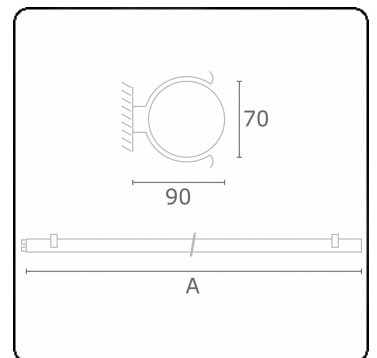

ENERGY

Verrijgbaar op aanvraag.

Disponible sur demande.

Available on request.

Auf Anfrage.

WXYZ
kWh/1000h

MULTILINE®

2019/2015