

Tube 70 T1 - clear - HO 150mA - standard  
35.90005543-0000

**Fixture details**

Mounting	Wall
Light emission	Direct
Fitting cover	clear diffuser
Protection rate	IP 65
Housing	Polycarbonate
Finish	frosted
Certificates	CE, ISO 9001



**Electric details**

Protection class	I
Supply	230V
Control gear box	Current driver DALI/TD
Emergency set	Autonomy 1 hour DALI

**Lamp details**

Lamptype	LED 3000K
Wattage	3,2W
Gross luminous flux	2560
Luminaire power	14,1W
Number	4
Lifetime LED module	L80/B10 > 72000h
Color tolerance	MacAdam 3
CRI	>80

**Photometric details**

CIE Fluxcode	44 73 91 88 86
--------------	----------------

**Dimensions**

A	1200 mm
---	---------

**Remarks**

Wall luminaire - clear - HO 150mA - standard

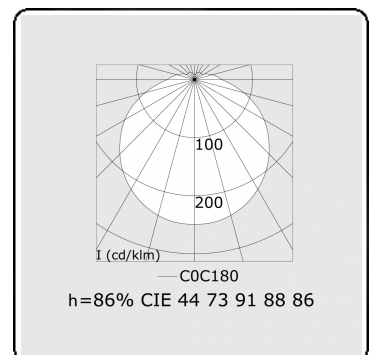

**ENERGY**

Verkrijgbaar op aanvraag.

Disponible sur demande.

Available on request.

Auf Anfrage.

**WXYZ**  
kWh/1000h

**MULTILINE®**

2019/2015