

Re-LED Direct/Indirect    satin - HO 225mA - RAL  
04.91104894-9999

**Fixture details**

Mounting	Pendant
Light emission	Direct-Indirect
Fitting cover	satin diffusor
Protection rate	IP 20
Housing	Aluminium
Finish	RAL colour at your choice
Certificates	CE, ISO 9001

**Electric details**

Protection class	I
Supply	230V
Control gear box	Current driver DALI/TD

**Lamp details**

Lamptype	LED 4000K
Wattage	6,7W
Gross luminous flux	23940
Luminaire power	137,6W
Number	9
Lifetime LED module	L80/B10 > 72000h
Color tolerance	MacAdam 3
CRI	>80 + 9x LED 4000K 7,2W

**Photometric details**

UGR	>19
CIE Fluxcode	49 80 96 99 70
CIE Fluxcode Indirect	00 00 00 00 73

**Dimensions**

A	2608 mm
---	---------

**Remarks**

Suspended luminaire - Direct - HO 225mA - satin (flush) - RAL

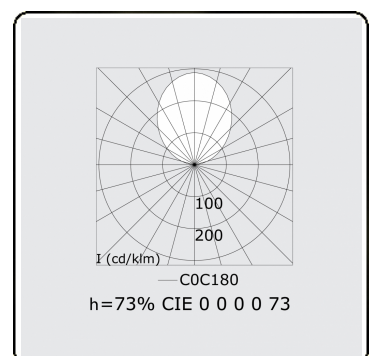
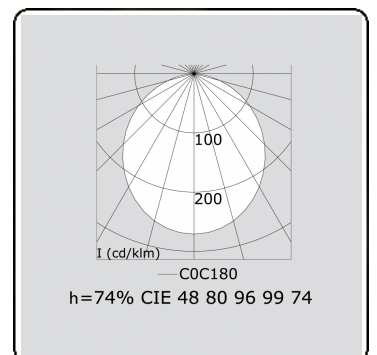
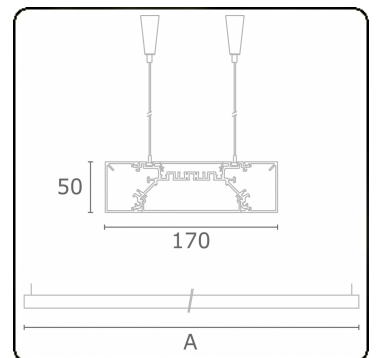

**ENERGY**

Verkrijgbaar op aanvraag.

Disponible sur demande.

Available on request.

Auf Anfrage.

**WXYZ**  
kWh/1000h

**MULTILINE®**

2019/2015