

Ro-LED Direct - VDT - HO 325mA - ANO
05.92020654-0001

Fixture details

Mounting	Ceiling
Light emission	Direct
Fitting cover	VDT louvre
Protection rate	IP 20
Housing	Aluminium
Finish	anodized finish
Certificates	CE, ISO 9001



Electric details

Protection class	I
Supply	230V
Control gear box	Current driver

Lamp details

Lamptype	LED 4000K
Wattage	7,2W
Gross luminous flux	6700
Luminaire power	39,6W
Number	5
Lifetime LED module	L80/B10 > 72000h
Color tolerance	MacAdam 3
CRI	>80

Photometric details

UGR	<19
CIE Fluxcode	80 99 100 100 71

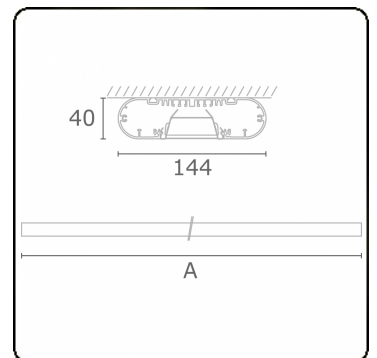

Dimensions

A	1410 mm
---	---------

Remarks

Ceiling luminaire - Direct - HO 325mA - VDT - ANO

ENERGY

Verrijgbaar op aanvraag.

Disponible sur demande.

Available on request.

Auf Anfrage.

WXYZ
kWh/1000h

MULTILINE®

2019/2015