

Rekta 65x90 Direct/Indirect - VDT - HO 150mA - RAL
04.94324583-9999

Fixture details

Mounting	Pendant
Light emission	Direct-Indirect
Fitting cover	VDT louvre
Protection rate	IP 20
Housing	Aluminium
Finish	RAL colour at your choice
Certificates	CE, ISO 9001

Electric details

Protection class	I
Supply	230V
Control gear box	Current driver DALI/TD

Lamp details

Lamptype	LED 3000K
Wattage	3,2W
Gross luminous flux	9525
Luminaire power	52,7W
Number	15
Lifetime LED module	L80/B10 > 72000h
Color tolerance	MacAdam 3
CRI	>80

Photometric details

UGR	<19
CIE Fluxcode	80 99 100 100 76
CIE Fluxcode Indirect	00 00 00 00 67

Dimensions

A	2250 mm
---	---------

Remarks

Suspended luminaire - Direct/Indirect - HO 150mA - VDT - RAL

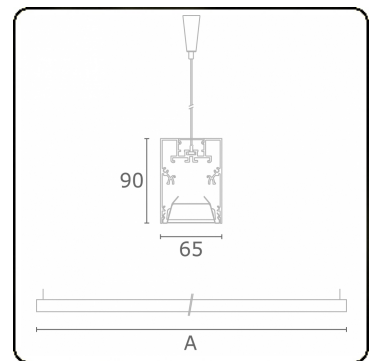

ENERGY

Verrijgbaar op aanvraag.

Disponible sur demande.

Available on request.

Auf Anfrage.

WXYZ
kWh/1000h

MULTILINE®

2019/2015

