

Scorta Direct - satin - HO - ANO
04.86002224-0001

Fixture details

Mounting	Pendant
Light emission	Direct
Fitting cover	Opal diffuser
Protection rate	IP 20
Housing	Aluminium
Finish	anodized finish
Certificates	CE, ISO 9001



Electric details

Protection class	I
Supply	230V
Control gear box	Current driver 1-10V



Lamp details

Lamptype	LED 4000K
Wattage	29W
Luminaire power	29W
Luminaire luminous flux	3550
Number	1
Lifetime LED module	L80/B10 = 50000h
Color tolerance	MacAdam 3
CRI	>80

Photometric details

UGR	>19
CIE Fluxcode	46 77 94 100 100

Dimensions

A	430 mm
---	--------

Remarks

Suspended luminaire - Direct - satin - HO - ANO

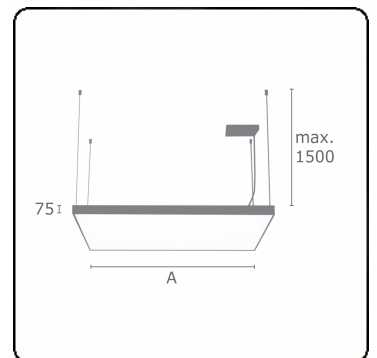

ENERGY

Verrijgbaar op aanvraag.

Disponible sur demande.

Available on request.

Auf Anfrage.

WXYZ
kWh/1000h

MULTILINE®

2019/2015