

Scorta Direct - satin - HO - ANO  
04.86002253-0001

**Fixture details**

Mounting	Pendant
Light emission	Direct
Fitting cover	Opal diffuser
Protection rate	IP 20
Housing	Aluminium
Finish	anodized finish
Certificates	CE, ISO 9001



**Electric details**

Protection class	I
Supply	230V
Control gear box	Current driver 1-10V



**Lamp details**

Lamptype	LED 3000K
Wattage	129W
Luminaire power	129W
Luminaire luminous flux	12753
Number	1
Lifetime LED module	L80/B10 = 50000h
Color tolerance	MacAdam 3
CRI	>80

**Photometric details**

UGR	>19
CIE Fluxcode	46 77 94 100 100

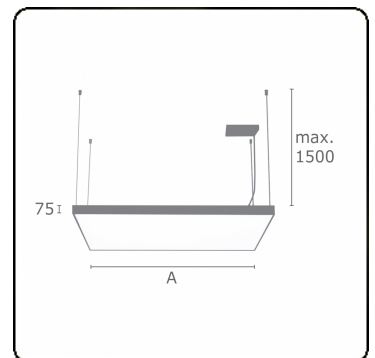

**Dimensions**

A	900 mm
---	--------

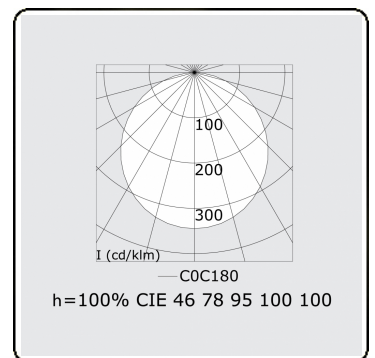

**Remarks**

Suspended luminaire - Direct - satin - HO - ANO

**ENERGY**

Verrijgbaar op aanvraag.

Disponible sur demande.

Available on request.

Auf Anfrage.

**WXYZ**  
kWh/1000h

**MULTILINE®**

2019/2015