

Plato 0 Direct - satin - HO 150mA - Anthracite grey  
31.13000534-7916

**Fixture details**

Mounting	Pendant
Light emission	Direct
Fitting cover	satin diffusor
Protection rate	IP 20
Housing	Aluminium/PET
Finish	7916 = Anthracite grey panel and profile
Certificates	CE, ISO 9001

**Electric details**

Protection class	I
Supply	230V
Control gear box	Current driver

**Lamp details**

Lamptype	LED 4000K
Wattage	3,2W
Gross luminous flux	4020
Luminaire power	21,1W
Number	6
Lifetime LED module	L80/B10 > 72000h
Color tolerance	MacAdam 3
CRI	80

**Photometric details**

UGR	>19
CIE Fluxcode	50 80 96 100 67

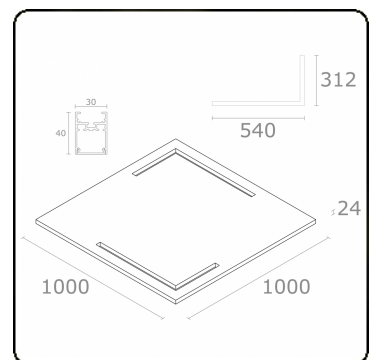
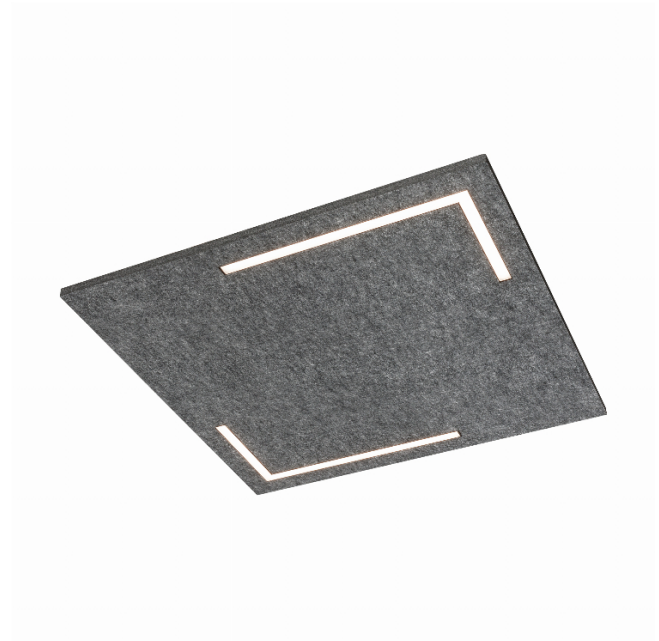

**ENERGY**

Verrijgbaar op aanvraag.

Disponible sur demande.

Available on request.

Auf Anfrage.

**WXYZ**  
kWh/1000h

**MULTILINE®**

2019/2015