

Maze - I - Suspended - satin - HO 150mA - RAL
04.18004523-9999

Fixture details

Mounting	Pendant
Light emission	Direct
Fitting cover	satin diffusor
Protection rate	IP 20
Housing	Aluminium
Finish	RAL colour at your choice
Certificates	CE, ISO 9001

Electric details

Protection class	I
Supply	230V
Control gear box	Power supply DALI - 1 supply point

Lamp details

Lamptype	LED 3000K
Wattage	3,2W
Gross luminous flux	1280
Luminaire power	7W
Number	2
Lifetime LED module	L80/B10 > 72000h
Color tolerance	MacAdam 3
CRI	80

Photometric details

CIE Fluxcode	49 80 96 100 66
--------------	-----------------

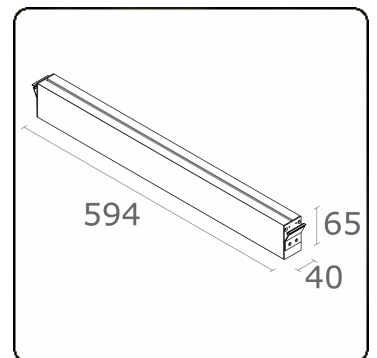

ENERGY

Verkrijgbaar op aanvraag.

Disponible sur demande.

Available on request.

Auf Anfrage.

WXYZ
kWh/1000h

MULTILINE® 2019/2015