

Vivace 7.2
06.23793-9905

Fixture details

Mounting	Wall
Light emission	Direct or Indirect
Fitting cover	Glass
Protection rate	IP 20
Housing	Aluminium
Finish	RAL 9011 graphite black textured
Certificates	CE, ISO 9001

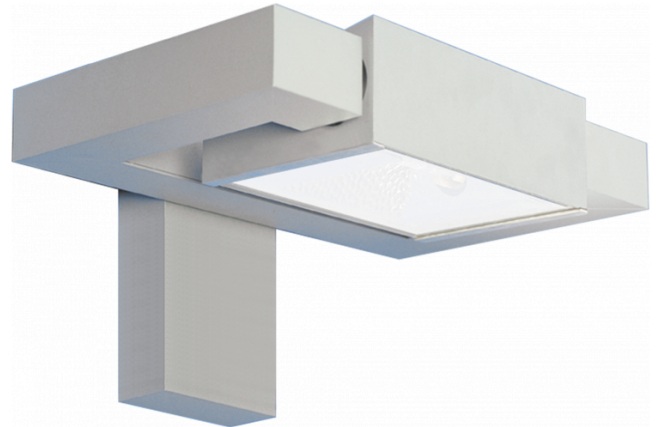

Electric details

Protection class	I
Supply	230V
Control gear box	EG

Lamp details

Lamptype	LED 4000K
Wattage	24W
Gross luminous flux	2560
Luminaire power	29W
Number	1
Lifetime LED module	L80/B10 = 50000h
Color tolerance	MacAdam 3
CRI	85

Photometric details

CIE Fluxcode	53 83 97 99 73
--------------	----------------

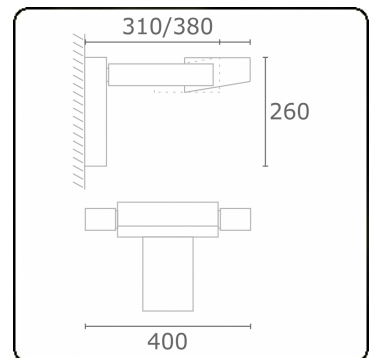

Remarks

TC-D and LED with sandblasted glass, other light sources with clear glass

ENERGY

Verrijgbaar op aanvraag.

Disponible sur demande.

Available on request.

Auf Anfrage.

WXYZ
kWh/1000h

MULTILINE®

2019/2015