

Snake - satiné - HO 150mA - RAL
04.48004564-9999

Armatuurgegevens

Montage	Gependeld
Lichtuittreding	Direct
Afscherming	satiné plexi
Beschermingsgraad	IP 20
Behuizing	Aluminium
Afwerking	RAL kleur naar keuze
Keurmerken	CE, ISO 9001



Elektrische Gegevens

Veiligheidsklasse	I
Voeding	230V
Voorschakelapparaat	Stroomvoeding DALI/TD

Lampgegevens

Lamptype	LED 4000K
Wattage	3,2W
Bruto lichtstroom	4020
Armatuur vermogen	21,1W
Aantal	6
Levensduur LED module	L80/B10 > 72000h
Kleurtolerantie	MacAdam 3
CRI	>80

Lichttechnische gegevens

UGR	>19
CIE Fluxcode	43 73 91 95 79

Afmetingen

A	1920 mm
---	---------

Opmerkingen

Pendelarmatuur - Direct - HO 150mA - satiné - RAL

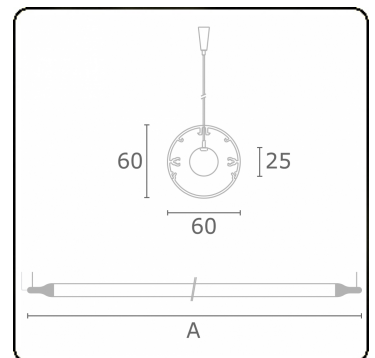

ENERGY

Verrijgbaar op aanvraag.

Disponible sur demande.

Available on request.

Auf Anfrage.

WXYZ
kWh/1000h

MULTILINE®

2019/2015