

Snake - satin - HO 150mA - RAL  
06.48004523-9999

**Fixture details**

Mounting	Wall
Light emission	Direct
Fitting cover	satin diffusor
Protection rate	IP 20
Housing	Aluminium
Finish	RAL colour at your choice
Certificates	CE, ISO 9001



**Electric details**

Protection class	I
Supply	230V
Control gear box	Current driver DALI/TD

**Lamp details**

Lamptype	LED 3000K
Wattage	3,2W
Gross luminous flux	1280
Luminaire power	7,0W
Number	2
Lifetime LED module	L80/B10 > 72000h
Color tolerance	MacAdam 3
CRI	>80

**Photometric details**

UGR	>19
CIE Fluxcode	43 73 91 95 79

**Dimensions**

A	950 mm
---	--------

**Remarks**

Wall luminaire - Direct - HO 150mA satin - RAL

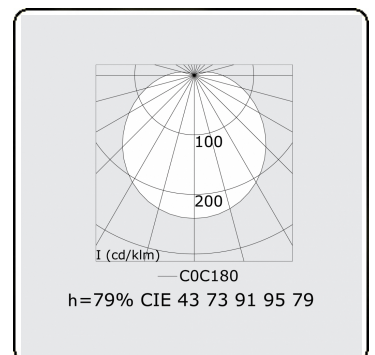
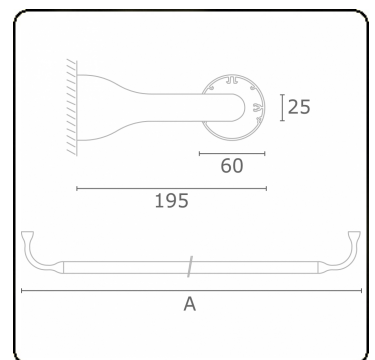

**ENERGY**

Verkrijgbaar op aanvraag.

Disponible sur demande.

Available on request.

Auf Anfrage.

**WXYZ**  
kWh/1000h

**MULTILINE®**

2019/2015